



Barbara Jean
• COLLECTION •

Linger longer
with Barbara Jean

Outdoor Fire Collection

Unit illustrated is a OLT48BMAPT Outdoor Fire Table
(48" Propane Burner), Black with Brown Accents,
Bronze Glass Media, Weather Cover and Wind Guard.
Optional accessories include: MQRBD3 Driftwood
(5 pc set), MQSTONE10 Decorative Stones (10 pc set).

Wouldn't it be great if summer lasted forever?

Now you can enjoy more outdoor living at your home or cottage with the new outdoor fire collection from Barbara Jean.

The Barbara Jean collection features an array of customizable burners, fire stands, tables and fireplaces that allow you to create an enticing ambiance for cocktail hour and al fresco dining on your patio or deck.

Special times just got a whole lot warmer with the beauty of the new Barbara Jean Collection. Come see it today!





A

Unit illustrated is a OLT48BMAPT Outdoor Fire Table (48" Burner), Black with Brown Accents, Bronze Glass, Weather Cover and Wind Guard. *Optional accessories include: MQRBD3 Driftwood (5 pc set), MQSTONE10 Decorative Stones (10 pc set).*

B

Unit illustrated is a OFS48MAPT Fire Stand with Linear Burner (Manual/Propane), MQG5C Glass Media (Bronze x4), OB48WG Wind Guard.

C

Unit illustrated is a OFP7972S2N Outdoor Linear Fireplace (See Through – Natural Gas/Millivolt), MQG5C Glass Media (Bronze x6).

Fire Tables

Imagine family and friends gathered around a mesmerizing ribbon of fire on the Barbara Jean Fire Table. Available in three sizes and two colour options, you can create your own designer look with your choice of ember glass, driftwood logs, decorative stones and rocks.



A

A

Unit illustrated is a OLT48GMAPT Outdoor Fire Table (48" Propane Burner), Black with Gray Accents, Bronze Glass Media, Weather Cover and Wind Guard. *Optional accessories include: MQRBD3 Driftwood (5 pc set), MQSTONE10 Decorative Stones (10 pc set).*

B / C

Unit illustrated is a OLT48BMAPT Outdoor Fire Table (48" Propane Burner), Black with Brown Accents, Bronze Glass Media, Weather Cover and Wind Guard. *Optional accessories include: MQRBD3 Driftwood (5 pc set), MQSTONE10 Decorative Stones (10 pc set).*



B

C

Fire Tables

A



A

Unit illustrated is a OLT48BMAPT Outdoor Fire Table (48" Propane Burner), Black with Brown Accents, Bronze Glass Media, Weather Cover and Wind Guard. *Optional accessories include: MQRBD3 Driftwood (5 pc set), MQSTONE10 Decorative Stones (10 pc set).*

Fire Tables are assembled – includes Wind Guard, Weather Cover and Bronze Glass Media.

Certified for USA and Canada: Outdoor Decorative Gas Appliance.

Table Sizes

24" WIDE

OLT24GMAPT
Black w/ Grey trim

OLT24BMAPT
Black w/ Brown trim

Dimensions (A) x (B)
42 13/16" L x 28 5/16" W

Linear Burner 24"
Manual Valve
with Spark Igniter
Propane
41,000 BTU

36" WIDE

OLT36GMAPT
Black w/ Grey trim

OLT36BMAPT
Black w/ Brown trim

Dimensions (A) x (B)
54 13/16" L x 28 5/16" W

Linear Burner 36"
Manual Valve
with Spark Igniter
Propane
60,000 BTU

48" WIDE

OLT48GMAPT
Black w/ Grey trim

OLT48BMAPT
Black w/ Brown trim

Dimensions (A) x (B)
66 13/16" L x 28 5/16" W

Linear Burner 48"
Manual Valve
with Spark Igniter
Propane
60,500 BTU

Manual Valve Systems are shipped as Propane, NG conversion orifice is included with burner.

Glass Media Options

Tables include Bronze Glass. 5 lbs per foot of burner (ie: 24" burner = 10 lbs)

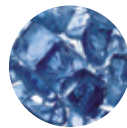

MQG5A
1/2" Cobalt Blue
5 lbs

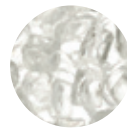

MQG5W
1/2" White
5 lbs



MQG5C
1/2" Bronze
5 lbs



MQG5B
1/2" Black
5 lbs

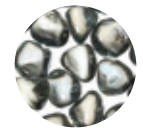

MQG5ZG
Zircon Glacier Ice
5 lbs

Table Colour Options

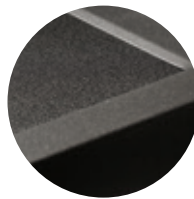

Black with
Grey trim

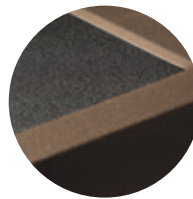

Black with
Brown trim

Table Top (AxB)

24" 42 13/16" L x 28 5/16" W

36" 54 13/16" L x 28 5/16" W

48" 66 13/16" L x 28 5/16" W

Table Base (C)

24" 33 7/8" L

36" 45 7/8" L

48" 57 7/8" L

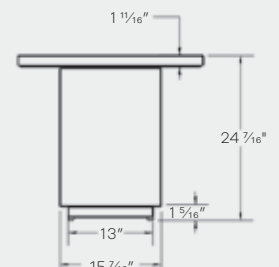
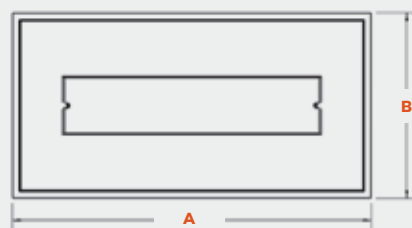

Burners

Completely flexible, the Barbara Jean Burner is the perfect project for do-it-yourselfers. Five sizes available (24, 36, 48, 72, 96") and for longer lengths simply link them together to create your own custom size!

Plus, a variety of beautiful log, decorative stone and rock options ensure you create the look you want. When you have achieved your desired look, invite family and friends to gather around for a perfect get together outdoors.



A

Unit illustrated is a OB48MVN Linear Burner (Millivolt/Natural Gas), MQG5C Glass Media (Bronze x4), MQSTONE Decorative Stones, OB48WG Wind Guard.

B

Unit illustrated is a OB48MVN Linear Burner (Millivolt/Natural Gas), MQG5C Glass Media (Bronze x4), MQSTONE Decorative Stones.



Burners

A



A

Unit illustrated is a OB72MVN Linear Burner (Millivolt/Natural Gas), MQG5C Glass Media (Bronze x6), MQSTONE Decorative Stones.

Linear Outdoor Burner Systems

Certified for USA and Canada: Outdoor Decorative Gas Appliance.

<p>24"</p> <p>OB24MVN Linear Burner 24" Millivolt Valve <i>with Piezo Igniter</i> Natural Gas 40,000 BTU</p> <p>Dimensions (A) x (B) 26"L x 7 1/2"W</p> <p>24OB-CKLP Conversion Kit to Propane Millivolt</p>	<p>36"</p> <p>OB36MVN Linear Burner 36" Millivolt Valve <i>with Piezo Igniter</i> Natural Gas 60,000 BTU</p> <p>Dimensions (A) x (B) 38"L x 7 1/2"W</p> <p>36OB-CKLP Conversion Kit to Propane Millivolt</p>	<p>48"</p> <p>OB48MVN Linear Burner 48" Millivolt Valve <i>with Piezo Igniter</i> Natural Gas 80,000 BTU</p> <p>Dimensions (A) x (B) 50"L x 7 1/2"W</p> <p>48OB-CKLP Conversion Kit to Propane Millivolt</p>	<p>72"</p> <p>OB72MVN Linear Burner 72" Millivolt Valve <i>with Piezo Igniter</i> Natural Gas[*] 120,000 BTU</p> <p>Dimensions (A) x (B) 74"L x 7 1/2"W</p> <p>72OB-CKLP Conversion Kit to Propane Millivolt</p>	<p>96"</p> <p>OB96MVN Linear Burner 96" Millivolt Valve <i>with Piezo Igniter</i> Natural Gas[*] 156,000 BTU</p> <p>Dimensions (A) x (B) 98"L x 7 1/2"W</p> <p>96OB-CKLP Conversion Kit to Propane Millivolt</p>
--	--	--	---	---

Glass Media Required

5 lbs per foot of burner (ie: 24" burner = 10 lbs)

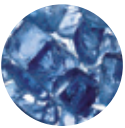

MQG5A
1/2" Cobalt Blue
5 lbs



MQG5W
1/2" White
5 lbs



MQG5C
1/2" Bronze
5 lbs



MQG5B
1/2" Black
5 lbs

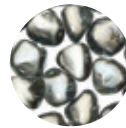

MQG5ZG
Zircon Glacier Ice
5 lbs

Wind Guard Recommended

5 1/2"H (4 pc set)

- OB24WG**
for 24" Burners OB24
- OB36WG**
for 36" Burners OB36
- OB48WG**
for 48" Burners OB48
- OB72WG**
for 72" Burners OB72
- OB96WG**
for 96" Burners OB96



Top View



Side View



All burners are manufactured with Satin Coat steel with a high temperature black paint finish. Satin Coat steel is pretreated with a Zinc coating for corrosion resistance and paint adhesion.

End View

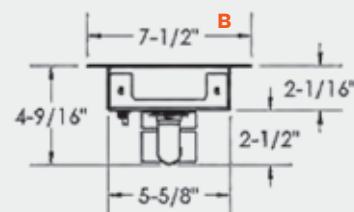

Fire Stands

Completely portable and stand-alone, the Barbara Jean Fire Stand is perfect for any outdoor space, season or occasion. Gather friends and family around a mesmerizing ribbon of fire and enjoy every occasion outdoors. Three sizes plus a variety of ember glass, driftwood logs, decorative stones and rock options ensure you create the look you want.



A

Unit illustrated is a OFS48MAPT Fire Stand Linear Burner (Manual/Propane), MQG5C Glass Media (Bronze x4), MQSTONE10 Decorative Stones (10 pc set x2), OB48WG Wind Guard.

B

Unit illustrated is a OFS48MAPT Linear Fire Stand (Manual/Propane), MQG5C Glass Media (Bronze x4), OB48WG Wind Guard.

C

Unit illustrated is a OFS48MAPT Fire Stand Linear Burner (Manual/Propane), MQG5C Glass Media (Bronze x4), MQSTONE10 Decorative Stones (10 pc set x2).

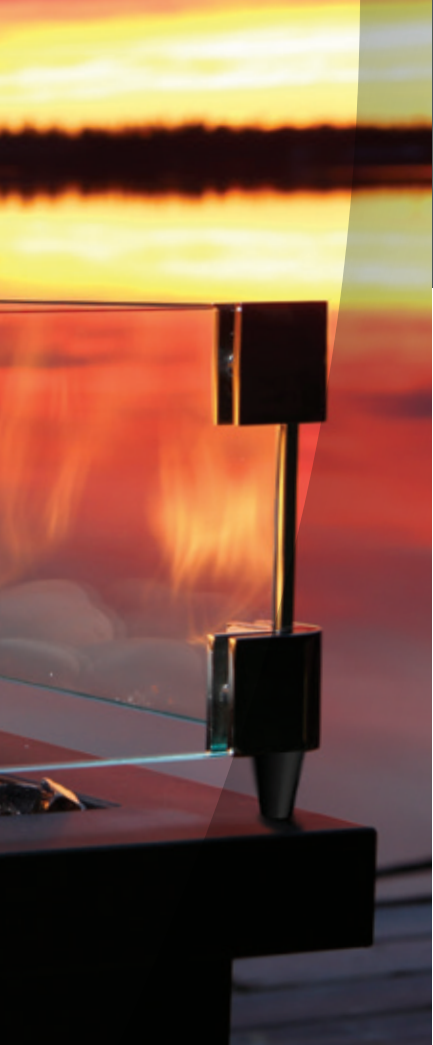

Linear Outdoor Fire Stands

Certified for USA and Canada: Outdoor Decorative Gas Appliance.

24"

Fire Stand with
24" Linear Burner

OFS24MAPT
Manual Valve Propane*
with Spark Igniter
(41,000 BTU)

36"

Fire Stand with
36" Linear Burner

OFS36MAPT
Manual Valve Propane*
with Spark Igniter
(60,000 BTU)

48"

Fire Stand with
48" Linear Burner

OFS48MAPT
Manual Valve Propane*
with Spark Igniter
(60,500 BTU)

*Propane Fire Stands includes 10 ft. Hose and Regulator and natural gas conversion orifice.

Glass Media Required

5 lbs per foot of burner (ie: 24" burner = 10 lbs)

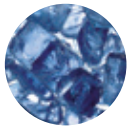

MQG5A
½" Cobalt Blue
5 lbs



MQG5W
½" White
5 lbs



MQG5C
½" Bronze
5 lbs



MQG5B
½" Black
5 lbs

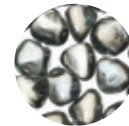

MQG5ZG
Zircon Glacier Ice
5 lbs

Wind Guard Recommended

5 ½"H (4 pc set)

OB24WG
for 24" Burners OB24

OB36WG
for 36" Burners OB36

OB48WG
for 48" Burners OB48



C

Dimensions

	24"	36"	48"
A	30 5/8"	42 5/8"	54 5/8"
B	12 13/16"	12 13/16"	12 13/16"
C	8 3/16"	8 3/16"	8 3/16"
D	26"	38"	50"
E	24"	36"	48"
F	7 1/2"	7 1/2"	7 1/2"
G	2 1/4"	2 1/4"	2 1/4"
H	6 1/16"	6 1/16"	6 1/16"
I	28 1/4"	40 1/4"	52 1/4"
J	23 5/16"	35 5/16"	47 5/16"
K	1 1/2"	1 1/2"	1 1/2"
L	2 1/2"	2 1/2"	2 1/2"
M	1 3/16"	1 3/16"	1 3/16"
N	3/4"	3/4"	3/4"
O	9 13/16"	9 13/16"	9 13/16"
P	4 3/16"	4 3/16"	4 3/16"
Q	1 3/4"	1 3/4"	1 3/4"

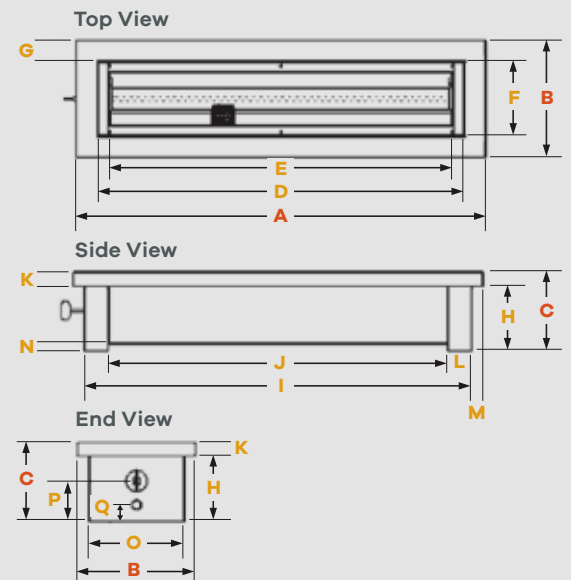

Outdoor Linear Fireplaces

Dramatically change the look and feel of your patio with the sleek, clean-view style of the Barbara Jean Collection Outdoor Linear Fireplace. Choose from a single sided or see-through option and three sizes to suit your outdoor space. Bringing your vision to life is simple with accents of ember glass, driftwood logs, and decorative stones and rocks.



A

Unit illustrated is a OFP7972S2N Outdoor Linear Fireplace (See Through – Millivolt/Natural Gas), with MQG5C Glass Media (Bronze x6), OFP79SS Stainless Steel Surround.



A

Outdoor Linear Fireplaces



Unit illustrated is a OFP7972S1N Outdoor Linear Gas Fireplace (Single Sided – Millivolt/Natural Gas), MQG5C Glass Media (Bronze x6), MQRBD3 Driftwood (5 pc set), MQSTONE Decorative Stones.

B



Unit illustrated is a OFP5548S1N Outdoor Linear Gas Fireplace (Single Sided – Millivolt/Natural Gas), MQG5C Glass Media (Bronze x4), RBCB1 Cannonballs (Assorted 14 pc set).

Outdoor Linear Fireplaces

Certified for USA and Canada: Outdoor Decorative Gas Appliance.

36"

OFP4336S1N
Linear Fireplace
Single Side

OFP4336S2N
Linear Fireplace
See Through

Linear Burner 36"
Millivolt Valve
with Piezo Igniter
Natural Gas
60,000 BTU

36OB-CKLP
Conversion Kit
to Propane Millivolt

48"

OFP5548S1N
Linear Fireplace
Single Side

OFP5548S2N
Linear Fireplace
See Through

Linear Burner 48"
Millivolt Valve
with Piezo Igniter
Natural Gas
80,000 BTU

48OB-CKLP
Conversion Kit
to Propane Millivolt

72"

OFP7972S1N
Linear Fireplace
Single Side

OFP7972S2N
Linear Fireplace
See Through

Linear Burner 72"
Millivolt Valve
with Piezo Igniter
Natural Gas
120,000 BTU

72OB-CKLP
Conversion Kit
to Propane Millivolt

Glass Media Required

5 lbs per foot of burner (ie: 24" burner = 10 lbs)

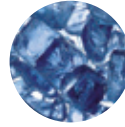

MQG5A (5 lbs)
1/2" Cobalt Blue



MQG5W (5 lbs)
1/2" White



MQG5C (5 lbs)
1/2" Bronze



MQG5B (5 lbs)
1/2" Black

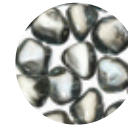

MQG5ZG (5 lbs)
Zircon Glacier Ice

Dimensions

36"

OFP4336S1N

A	19 1/4"
B	18 1/8"
C	3/4"
D	19 1/16"
E	3/8"
F	57 1/4"
G	5"
H	40 7/16"
I	18 1/8"
J	19 1/4"
K	35 1/2"
L	5"
M	9 9/16"
N	42 15/16"
O	16 5/16"
P	7 1/8"
Q	57 1/4"

48"

OFP5548S1N

A	19 1/4"
B	18 1/8"
C	3/4"
D	19 1/16"
E	3/8"
F	69 1/4"
G	5"
H	40 7/16"
I	18 1/8"
J	19 1/4"
K	35 1/2"
L	5"
M	9 9/16"
N	54 15/16"
O	16 5/16"
P	7 1/8"
Q	69 1/4"

72"

OFP7972S1N

A	19 1/4"
B	18 1/8"
C	3/4"
D	19 1/16"
E	3/8"
F	93 1/4"
G	5"
H	40 7/16"
I	18 1/8"
J	19 1/4"
K	35 1/2"
L	5"
M	9 9/16"
N	78 15/16"
O	16 5/16"
P	7 1/8"
Q	93 1/4"

OFP4336S2N

A	18 7/8"
B	18 1/8"
C	3/8"
D	17 1/16"
E	3/8"
F	57 1/4"
G	35 1/2"
H	18 1/8"
I	18 7/8"
J	9 9/16"
K	42 15/16"
L	16 5/16"
M	7 1/8"
N	57 1/4"

OFP5548S2N

A	18 7/8"
B	18 1/8"
C	3/8"
D	17 1/16"
E	3/8"
F	69 1/4"
G	35 1/2"
H	18 1/8"
I	18 7/8"
J	9 9/16"
K	54 15/16"
L	16 5/16"
M	7 1/8"
N	69 1/4"

OFP7972S2N

A	18 7/8"
B	18 1/8"
C	3/8"
D	17 1/16"
E	3/8"
F	93 1/4"
G	35 1/2"
H	18 1/8"
I	18 7/8"
J	9 9/16"
K	78 15/16"
L	16 5/16"
M	7 1/8"
N	93 1/4"

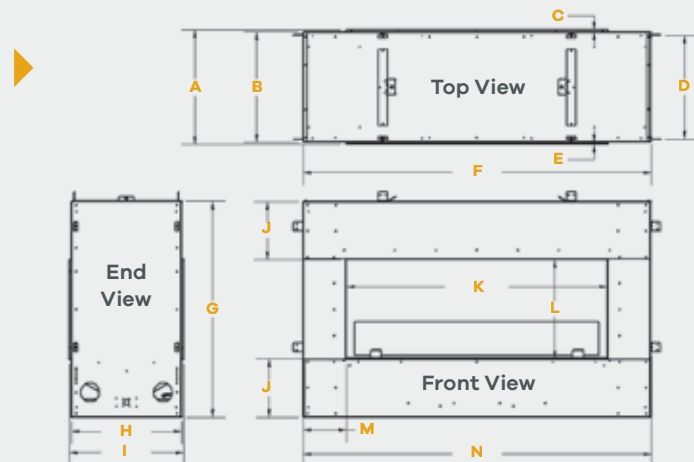
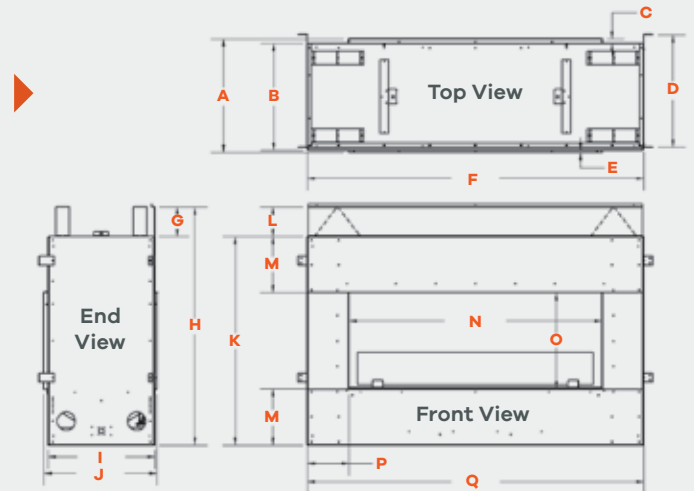

Outdoor Fire Pits

The Outdoor Fire Pit or Bowl is the perfect way to enhance your enjoyment of any outdoor space. Ideally suited for use on a wood deck or patio, the Outdoor Fire Pit and Bowl come complete with lava rock and are fuelled by either natural gas or propane. Decorate your Outdoor Fire Feature with the choice of decorative stones, or five different colors of crushed glass media.

The Outdoor Fire Pit can be installed on top of wood decks or patios, 24" clearance to side walls. Allow 7 ft. clearance from top of fire bowl to any ceiling.

Fire Bowl Colours



FPB32TBT
Textured
Black

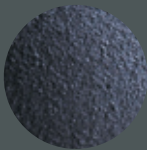

FPB30TBT
Textured
Charcoal



FPB30SGT
Smooth
Grey

A

Unit illustrated is a FP2085LPT Outdoor Fire Pit (Propane), FPB30SGT Smooth Grey Concrete Fire Bowl, FPB32TRG Trim Ring (Charcoal).

B

Unit illustrated is a FP2085LPT Outdoor Fire Pit (Propane), FPB32TBT Textured Black Fire Bowl, MQSTONES Decorative Stones (x2).

C

Unit illustrated is an FP2785LPT-FL Rectangular Outdoor Gas Fire Pit (Propane), LOGC85 Log Set.

D

Unit illustrated is an FP2085LPT Round Outdoor Gas Fire Pit (Propane), FPB30TBT Textured Charcoal Fire Bowl, MQG10C Bronze Reflective Glass (x4).





Outdoor Fire Pits

Certified for USA and Canada: Outdoor Decorative Gas Appliance.

ROUND

FP2085NT

Fuel: Natural
Input: 57,000 BTUH
Size: 20" Dia. x 4 1/2" H

FP2085LPT

Fuel: Propane
Input: 64,000 BTUH
Size: 20" Dia. x 4 1/2" H

30" BOWL

FPB30SGT

Smooth Grey
30" Dia. x 14" H

FPB30TBT

Textured Charcoal
30" Dia. x 14" H

32" BOWL

FPB32SGT

Smooth Grey
32" Dia. x 14 1/2" H

FPB32TBT

Textured Black
32" Dia. x 14 1/2" H

Standard Features

- Concrete Fire Bowl available in Smooth Grey and Textured Charcoal or Textured Black
- Choose either Natural Gas or Propane Fire Pit. Propane Fire Pit includes 5 ft. Hose and Regulator (Propane Tank not included)
- Lava Rock

Optional Features

Media: Decorative Ember Glass (Glacier Ice, Cobalt Blue, Black, Bronze, White), Decorative Stones

Log Set: Oak

Fire Bowl Trim Ring: Charcoal (FPB32TRG)
33 3/4" Dia. x 1 3/8" H

Fire Bowl Cover: Black (FPB30COVB)

RECTANGULAR

FP2785NT*

Fuel: Natural
Input: 57,000 BTUH
Size: 20" W x 27" L x 9" H

FP2785LPT-FL

Fuel: Propane
Input: 64,000 BTUH
Size: 20" W x 27" L x 9" H

**NOT STOCKED – order propane model and convert*

Standard Features

- Propane Fire Pit includes 5 ft. Hose and Regulator (Propane Tank not included)
- Lava Rock
- Flat Cover
- Natural Gas Conversion Orifice

Optional Features

Log Set: Oak

Fire Pit Cover: Black – FP27COV (for use with Log Set)

Media Options



MQG5C Bronze Ember Glass



MQG5W White Ember Glass



MQG5ZG Zircon Glacier Ice Glass

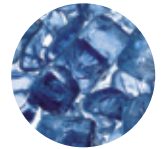

MQG5A Cobalt Ember Glass



MQG5B Black Ember Glass



MLR1410 Lava Rock



LOGC85 4-Piece Oak Log Set



MQSTONE Decorative Stone

Note for glass media: 5 lbs per foot of burner (ie: 24" burner = 10 lbs)



Outdoor Fireplaces

Light up your nights. Designed for your outdoor oasis, this fireplace captures your attention with its Satin Coat Black or Stainless Steel Finish and your choice of brick liner. Looks like the stars in the sky now have a little competition.

A



B



A

Unit illustrated is an OFP42N Outdoor Fireplace (Natural Gas), LOGF37 Split Oak Log Set, OFP42RLT Traditional Brick Liner.

B

Unit illustrated is an OFP42N Outdoor Fireplace (Natural Gas), LOGF37 Split Oak Log Set, OFP42RLH Herringbone Brick Liner.



Outdoor Fireplaces

Certified for USA and Canada: Outdoor Decorative Gas Appliance.

Natural Gas

OFP42N-BLACK
OFP42NS-STAINLESS

Input Max: 55,000 BTU
Input Min: 38,000 BTU

Propane

OFP42LP-BLACK
OFP42LPS-STAINLESS

Input Max: 55,000 BTU
Input Min: 44,000 BTU

Log Set (Ordered Separately)



LOGF37
Log Set
(Split Oak)

Standard Features

- Hi/lo Millivolt valve with variable adjustment of flame and BTU
- A flame sensor that constantly monitors the pilot flame and provides 100% gas shut off if pilot is not sensed
- Stainless steel pull screen
- Lava rock

Optional Features

Surround: Stainless steel

Refractory Liner: Traditional and Herringbone

Spark Assist: Battery operated pilot burner ignitor

Weather Cover: Stainless steel or black

Remote Control: On/Off

Surround



STAINLESS

Liners



OFP42RLT
Brick Liner
(Traditional)



OFP42RLH
Brick Liner
(Herringbone)

Screened Porch Installation Guidelines

- Porch Area – 96 sq. ft.
- Ceiling Height – 92"
- A minimum of two walls can be screened but must be open to outside ventilation:
Minimum Screen Height – 78"
Screen Area – 64 sq. ft

Refer to installation manual for additional details of framing specifications and clearances.

Dimensions

A	31 1/2"
B	44 1/2"
C	10 3/8"
D	42 1/8"
E	41 7/8"
G	43 1/2" min.
H	38 1/4"
I	18 1/2"
J	42 1/8"
K	38 1/4"
L	18 1/2"

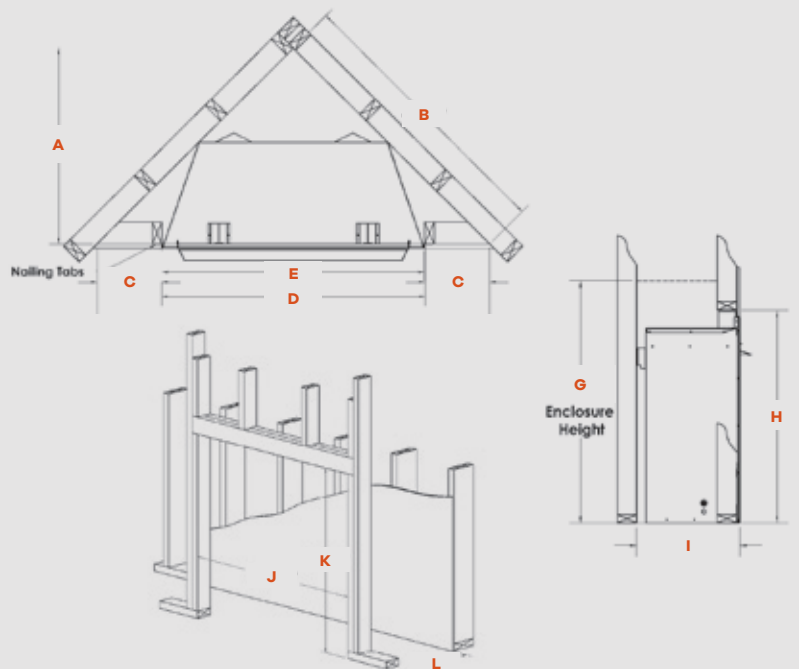

Accessories

The beauty of Barbara Jean Collection is that you can fully customize the look of your unit. Choose convenient accessories and designer options that range from classic driftwood logs to a more contemporary style of ember glass or rocks. Whatever you choose, you'll find the quality and unique style we're certain you'll warm up to.



Optional Accessories



MQRBD3
Log Set: Driftwood
(5 pc)



MQRBD4
Log Set: Driftwood
(3 pc)



MQROCK2
Rock Set: Contemporary
(Natural)



MQROCK3
Rock Set: Contemporary
(Multi-Colored)



RBCB1
Cannonballs: Assorted
size and colors (14 pc)



MQSTONE
Decorative Stones
(80 pc)



MQSTONE10
Decorative Stones
(10 pc)



GFRC
Black and Grey Remote
Millivolt (On/Off)



OFP42SA
Spark Assist for Millivolt Valve
(AA Battery not included)



OBUVM
Universal Valve Bracket Mount
(for Custom Applications)

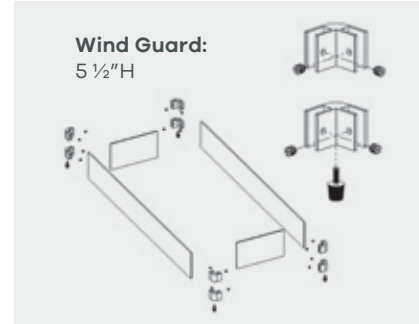

Wind Guard:
5 1/2"H

A

Unit illustrated is a OFS48MAPT Fire Stand Linear Burner (Manual/Propane), MQG5C Glass Media (Bronze x4), MQSTONE10 Decorative Stones (10 pc set x2), OB48WG Wind Guard



**Wind Guards
recommended for
Outdoor Burners**



OB24WG
for 24" Burners OB24
(4 pc set)

OB36WG
for 36" Burners OB36
(4 pc set)

OB48WG
for 48" Burners OB48
(4 pc set)

OB72WG
for 72" Burners OB72
(4 pc set)

OB96WG
for 96" Burners OB96
(4 pc set)



**Weather Covers
for Outdoor
Fire Tables**



OB24WWC for Wide 24" tables

OB36WWC for Wide 36" tables

OB48WWC for Wide 48" tables



**Optional Surround
for Outdoor Linear
Fireplaces**



Stainless Steel Surrounds

OFP43SS

OFP55SS

OFP79SS



**Optional Weather Covers
for Outdoor Linear Fireplaces**

OFP43WC Stainless Steel

OFP55WC Stainless Steel

OFP79WC Stainless Steel

A



Barbara Jean

· COLLECTION ·



The Barbara Jean Collection maintains a program of continuous testing, refinement and improvements of all its products. Some aspect of units shown here may be changed at any time without notice or obligation.

Certification: Certified for USA and Canada: Outdoor Decorative Gas Appliances.

*Components may have to be ordered separately to create a complete unit. Discuss with your local Dealer for clarification.

Printed in Canada | B0500 | 03/2022



Limited Warranty

The **OB Series burner** is warranted against defects for five years. All other components such as gas valves, thermocouples, igniters, lights and media are warranted against defects for one year.

The FP2085/2785 is warranted against defects for one year.



Crafted entirely in Canada, each Barbara Jean unit is built to the highest standards and made to last.



FOR CALIFORNIA RESIDENTS ONLY:

WARNING! This product can expose you to chemicals including Carbon Monoxide, that is an externally vented by-product of fuel consumption, which is [are] known to the State of California to cause birth defects or other reproductive harm. For more information, visit www.P65Warnings.ca.gov.

2340 Logan Ave.
Winnipeg, Manitoba
Canada R2R 2V3

Phone: 204.632.1962
Fax: 204.632.1960

BarbaraJeanCollection.com